

# CONTENITORI IN LAMIERA

## CONTAINERS IN SHEET METAL

GAMMA COMPLETA DI CONTENITORI IN LAMIERA. AFFIDABILI E SICURI, I CONTENITORI SALL IN LAMIERA PERMETTONO DI GESTIRE NEL MODO PIÙ RAZIONALE LA MOVIMENTAZIONE E LO STOCCAGGIO DI GRANDI VOLUMI DI MERCI. SONO DISPONIBILI IN NUMEROSI MODELLI, ANCHE A TENUTA STAGNA, CON DIFFERENTI CONFORMAZIONI E DIMENSIONI PER SODDISFARE QUALSIASI ESIGENZA.

COMPREHENSIVE RANGE OF SHEET METAL CONTAINERS. RELIABLE AND SAFE, WITH THE SALL SHEET METAL CONTAINERS WE CAN CONTROL THE HANDLING AND STORING OF GREAT VOLUMES OF GOODS IN A MORE RATIONAL MANNER. NUMEROUS MODELS ARE AVAILABLE, ALSO WATERTIGHT, IN DIFFERENT SHAPES AND SIZES TO MEET ALL REQUIREMENTS.





15

# CONTENITORI IN LAMIERA

## CONTAINERS IN SHEET METAL



MODELLO MODEL	DIMENSIONI . DIMENSIONS					PORTATA kg CAPACITY kg
	A	B	C	D	E	
<b>SL 1-8</b>	655	335	230	100	50	400

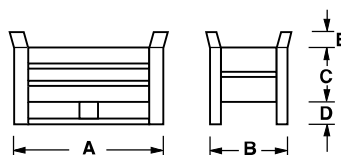

**SLITTA LATO LUNGO**  
SKID LONG SIDE

**PORTASCHEDA SALDATO,  
APERTURA SUL LATO**  
WELDED CARD HOLDER,  
OPEN AT THE SIDE



**ACCESSORI** ACCESSORIES  
PAG. 60

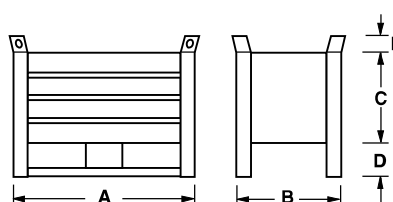

**SLITTA LATO LUNGO**  
SKID LONG SIDE

MODELLO MODEL	DIMENSIONI . DIMENSIONS					PORTATA kg CAPACITY kg
	A	B	C	D	E	
<b>SL 1-4</b>	800	460	400	150	65	800



**PORTA IN LAMIERA**  
SHEET-METAL DOOR

**PIEDE SCATOLATO**  
BOXED FOOT

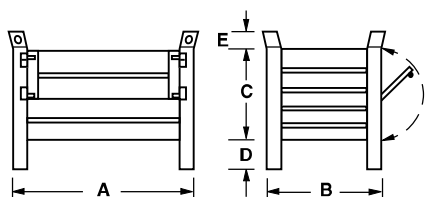

MODELLO MODEL	DIMENSIONI . DIMENSIONS					PORTATA kg CAPACITY kg
	A	B	C	D	E	
<b>SL 012</b>	800	500	500	130	65	600



**PORTA IN RETE**  
MESH DOOR

**PIEDE SCATOLATO**  
BOXED FOOT

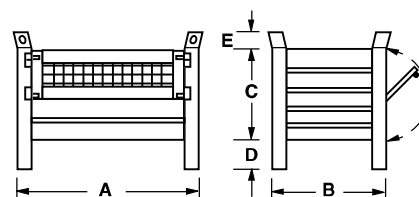

MODELLO MODEL	DIMENSIONI . DIMENSIONS					PORTATA kg CAPACITY kg
	A	B	C	D	E	
<b>SL 013</b>	800	500	500	130	65	600

# CONTENITORI IN LAMIERA

## CONTAINERS IN SHEET METAL

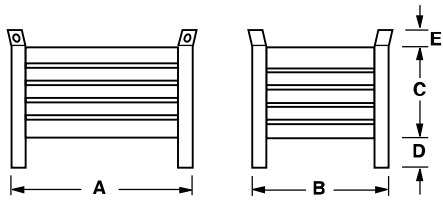

MODELLO MODEL	DIMENSIONI . DIMENSIONS					PORTATA kg CAPACITY kg
	A	B	C	D	E	
<b>SL 090</b>	800	500	500	130	65	600
<b>SL 010</b>	800	600	410	130	65	600
<b>SL 009</b>	800	600	500	130	65	600



**PIEDE SCATOLATO**  
BOXED FOOT

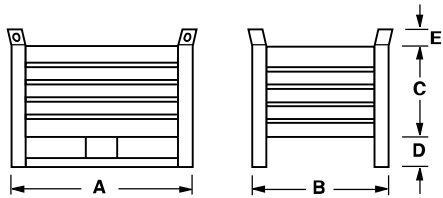

MODELLO MODEL	DIMENSIONI . DIMENSIONS					PORTATA kg CAPACITY kg
	A	B	C	D	E	
<b>SL 014</b>	800	500	500	130	65	800
<b>SL 015</b>	800	600	410	130	65	800
<b>SL 016</b>	800	600	500	130	65	800



**SLITTA LATO LUNGO**  
SKID LONG SIDE



MODELLO MODEL	DIMENSIONI . DIMENSIONS					PORTATA kg CAPACITY kg
	A	B	C	D	E	
<b>SL 082</b>	700	650	450	150	65	700
<b>SL 091</b>	800	500	500	130	65	700
<b>SL 092</b>	800	600	410	130	65	700
<b>SL 093</b>	800	600	500	130	65	700



**SLITTA LATO CORTO**  
SKID SHORT SIDE

**PARETE 3/4**  
SIDE 3/4

MODELLO MODEL	DIMENSIONI . DIMENSIONS					PORTATA kg CAPACITY kg
	A	B	C	D	E	
<b>SL 094</b>	800	500	500	130	65	700
<b>SL 095</b>	800	600	410	130	65	700
<b>SL 096</b>	800	600	500	130	65	700
<b>SL 026</b>	1000	800	450	130	65	1000

# CONTENITORI IN LAMIERA

## CONTAINERS IN SHEET METAL

### PIANO INTERNO INCLINATO

TILTED INTERNAL SURFACE

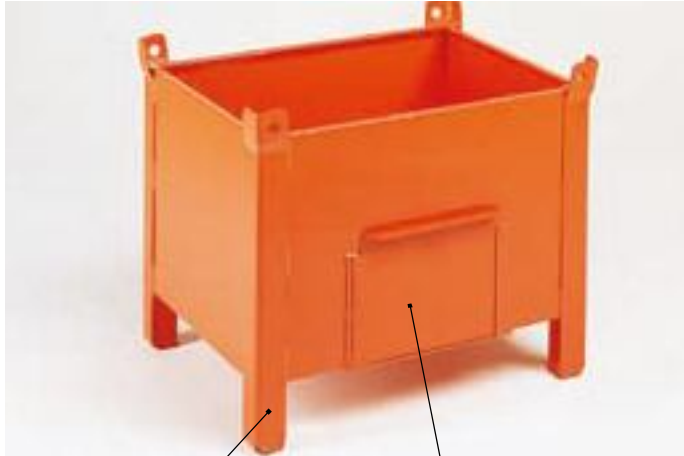

**PIEDE SCATOLATO** BOXED FOOT  
**TRAMOGGIA CON PORTA A GHILOTTINA** HOPPER WITH GUILLOTINE GATE

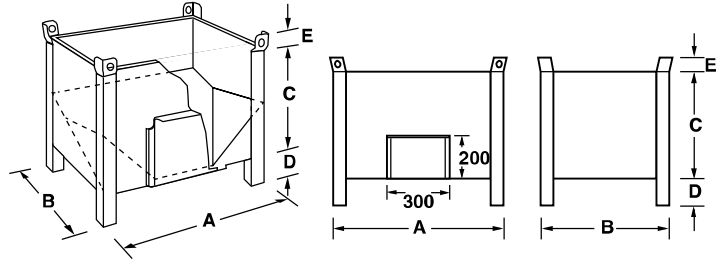

MODELLO MODEL	DIMENSIONI . DIMENSIONS					PORTATA kg CAPACITY kg
	A	B	C	D	E	
<b>SL 097</b>	800	600	500	130	65	700

**PORTASCHEDA SALDATO, APERTURA IN ALTO**  
 WELDED CARD HOLDER, OPENING AT THE TOP



**ACCESSORI ACCESSORIES PAG. 60**

### BORDO SUPERIORE IN TUBOLARE

UPPER TUBULAR EDGE



**SLITTA LATO CORTO** SKID SHORT SIDE  
**TELAIO DI BASE IN TUBOLARE** TUBULAR BASE FRAME

Pareti in lamiera liscia, nessun bordo interno, per facilitare lo scarico del materiale  
 Sides in plain sheet, no inside edge to facilitate unloading of the material

**COMPLETAMENTE A TENUTA STAGNA**  
**COMPLETELY WATERTIGHT**

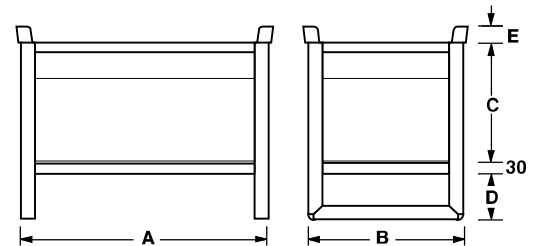

MODELLO MODEL	DIMENSIONI . DIMENSIONS					PORTATA kg CAPACITY kg
	A	B	C	D	E	
<b>SL 191</b>	800	500	400	150	45	1000

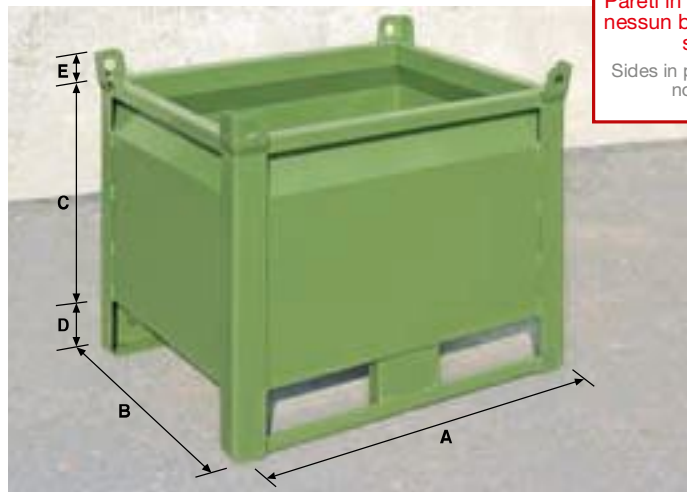

Pareti in lamiera liscia pressopiegata, nessun bordo interno, per facilitare lo scarico del materiale  
 Sides in plain sheet metal, press formed, no inside edge to facilitate unloading the material



MODELLO MODEL	DIMENSIONI . DIMENSIONS					PORTATA kg CAPACITY kg
	A	B	C	D	E	
<b>SL 192</b>	800	600	500	130	65	800





# CONTENITORI IN LAMIERA A BOCCA DI LUPO

CONTAINERS IN SHEET METAL RAKING MOUTH

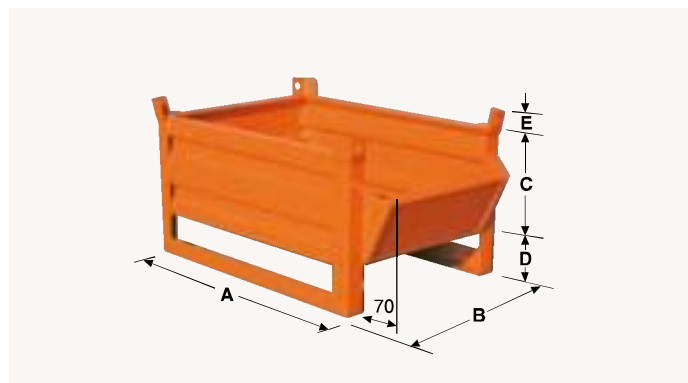

COMPOSIZIONE  
REALIZZATA CON IL  
MODELLO SL 201

COMPOSITION MADE  
WITH MODEL SL 201



MODELLO MODEL	DIMENSIONI . DIMENSIONS					PORTATA kg CAPACITY kg
	A	B	C	D	E	
<b>SL 201</b>	630	450	230	100	40	500



PIEDE SCATOLATO  
BOXED FOOT

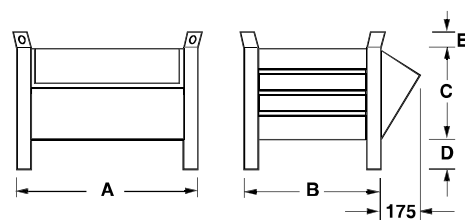

MODELLO MODEL	DIMENSIONI . DIMENSIONS					PORTATA kg CAPACITY kg
	A	B	C	D	E	
<b>SL 011</b>	800	600	410	130	65	600



PIEDE SCATOLATO TRIANGOLARE  
TRIANGULAR BOXED FOOT

MODELLO MODEL	DIMENSIONI . DIMENSIONS				PORTATA kg CAPACITY kg
	A	B	C	D	
<b>SL 130</b>	800	500	500	100	1000

**DIVISORIO MOBILE**  
**MOBILE PARTITION**

ARTICOLO  
ARTICLE  
DIV 130



SU RICHIESTA SLITTA LATO CORTO  
SKID ON SHORT SIDE AVAILABLE ON REQUEST

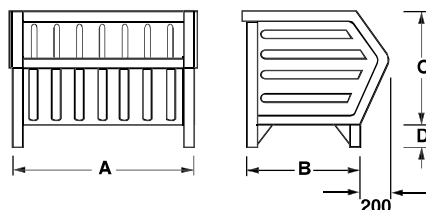



# CONTENITORI IN LAMIERA A BOCCA DI LUPO

CONTAINERS IN SHEET METAL RAKING MOUTH

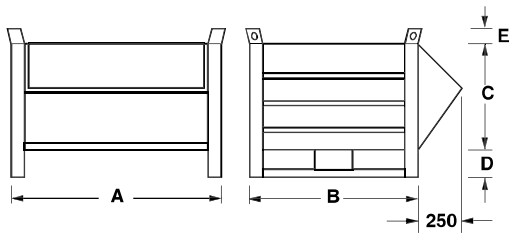

MODELLO MODEL	DIMENSIONI . DIMENSIONS					PORTATA kg CAPACITY kg
	A	B	C	D	E	
SL 018	1000	800	500	130	65	1000
SL 083	1000	800	650	130	65	1000
SL 084	1200	800	650	130	65	1000



SLITTA LATO CORTO  
SKID ON SHORT SIDE AVAILABLE

ETICHETTATURA AUTOADESIVA  
CON TARA AD ETTOGRAMMO  
SELF-ADHESIVE LABELLING  
WITH TARE IN HECTOGRAMS



ACCESSORI ACCESSORIES PAG. 61

SCRITTE STAMPATE IN RILIEVO  
WORDING PRINTED IN RELIEF



ACCESSORI ACCESSORIES PAG. 61

COMPOSIZIONE REALIZZATA  
CON IL MODELLO SL 130

COMPOSITION MADE  
WITH MODEL SL 130





# CONTENITORI IN LAMIERA

CONTAINERS IN SHEET METAL



PIEDE SCATOLATO  
BOXED FOOT

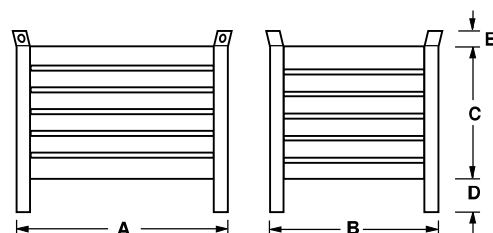

MODELLO MODEL	DIMENSIONI . DIMENSIONS					PORTATA kg CAPACITY kg
	A	B	C	D	E	
SL 008	1000	800	410	130	65	800
SL 005	1000	800	500	130	65	800
SL 001	1000	800	650	130	65	800
SL 076	1200	800	650	130	65	800



PORTA IN RETE  
MESH DOOR

PIEDE SCATOLATO  
BOXED FOOT

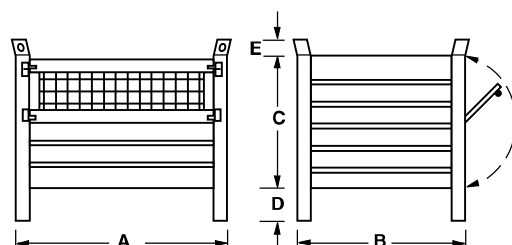

MODELLO MODEL	DIMENSIONI . DIMENSIONS					PORTATA kg CAPACITY kg
	A	B	C	D	E	
SL 007	1000	800	500	130	65	800
SL 002	1000	800	650	130	65	800
SL 077	1200	800	650	130	65	800

PORTASCHIEDE RIMOVIBILE  
REMOVABLE CARD HOLDER

ACCESSORI ACCESSORIES PAG. 60



PORTA IN LAMIERA  
SHEET-METAL DOOR

PIEDE SCATOLATO  
BOXED FOOT

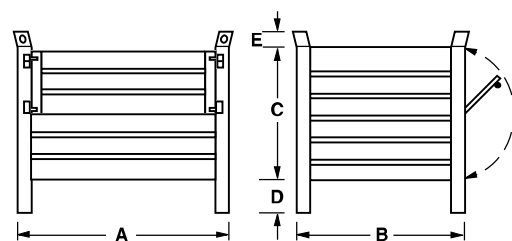

MODELLO MODEL	DIMENSIONI . DIMENSIONS					PORTATA kg CAPACITY kg
	A	B	C	D	E	
SL 006	1000	800	500	130	65	800
SL 003	1000	800	650	130	65	800
SL 055	1000	800	800	130	65	800
SL 078	1200	800	650	130	65	800
SL 057	1200	800	800	130	65	800

# CONTENITORI IN LAMIERA

## CONTAINERS IN SHEET METAL

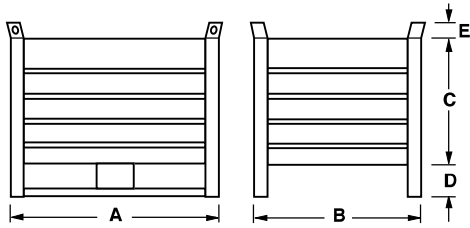

MODELLO MODEL	DIMENSIONI . DIMENSIONS					PORTATA kg CAPACITY kg
	A	B	C	D	E	
SL 021	1000	800	500	130	65	1000
SL 025	1000	800	650	130	65	1000
SL 027	1200	800	650	130	65	1000
SL 079	1200	1000	650	130	65	1000



SLITTA LATO LUNGO  
SKID LONG SIDE



TELAIO CON RUOTE PER  
MOVIMENTAZIONE CONTENITORI  
FRAME ON WHEELS FOR  
CONTAINER HANDLING  
PAG. 33

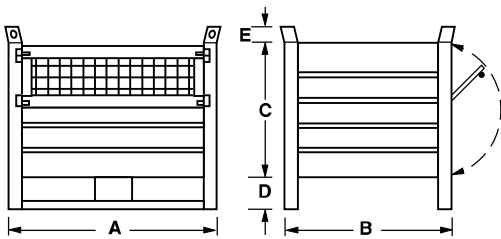

MODELLO MODEL	DIMENSIONI . DIMENSIONS					PORTATA kg CAPACITY kg
	A	B	C	D	E	
SL 019	1000	800	500	130	65	1000
SL 023	1000	800	650	130	65	1000
SL 029	1200	800	650	130	65	1000
SL 080	1200	1000	650	130	65	1000



PORTA IN RETE  
MESH DOOR

SLITTA LATO LUNGO  
SKID LONG SIDE

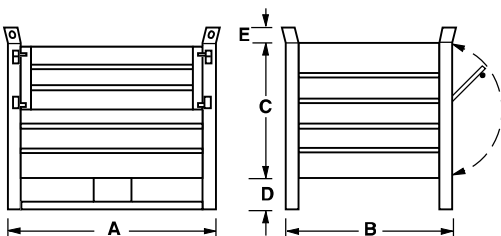

MODELLO MODEL	DIMENSIONI . DIMENSIONS					PORTATA kg CAPACITY kg
	A	B	C	D	E	
SL 020	1000	800	500	130	65	1000
SL 024	1000	800	650	130	65	1000
SL 059	1000	800	800	130	65	1000
SL 028	1200	800	650	130	65	1000
SL 067	1200	800	800	130	65	1000
SL 081	1200	1000	650	130	65	1000
SL 168	1200	1000	800	130	65	1000



PORTA IN LAMIERA  
SHEET-METAL DOOR

SLITTA LATO LUNGO  
SKID LONG SIDE

# CONTENITORI IN LAMIERA CON TELAIO

CONTAINERS IN SHEET METAL WITH FRAME

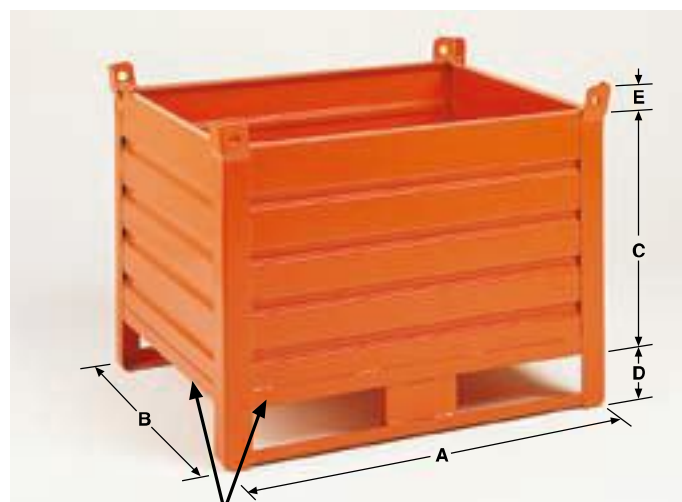

**ANGOLARE DI RINFORZO SUL FONDO**  
STRENGTHENING FRAME ON BOTTOM

**ANGOLARE DI RINFORZO SUL FONDO**  
STRENGTHENING FRAME ON BOTTOM

MODELLO MODEL	DIMENSIONI . DIMENSIONS					PORTATA kg CAPACITY kg
	A	B	C	D	E	
<b>SL 004</b>	1000	800	600	130	65	1000

MODELLO MODEL	DIMENSIONI . DIMENSIONS					PORTATA kg CAPACITY kg
	A	B	C	D	E	
<b>SL 022</b>	1000	800	600	130	65	1000

APERTURA PORTA CON SCORRIMENTO A GHIGLIOTTINA,  
PER UN MIGLIORE UTILIZZO DEL CONTENITORE IN SPAZI RIDOTTI

SLIDE-UP DOOR OPENING EASIER TO USE WHEN SPACE IS LIMITED



**PER SPAZI  
RIDOTTI  
WHEN SPACE  
IS LIMITED**



# CONTENITORI IN LAMIERA

## CONTAINERS IN SHEET METAL

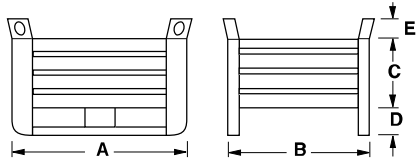

MODELLO MODEL	DIMENSIONI . DIMENSIONS					PORTATA kg CAPACITY kg
	A	B	C	D	E	
SL 033 M	1000	800	400	150	110	1500
SL 033 P	1000	800	400	150	110	2000
SL 085 M	1200	800	400	150	110	1500
SL 085 P	1200	800	400	150	110	2000



SLITTA LATO LUNGO  
SKID LONG SIDE

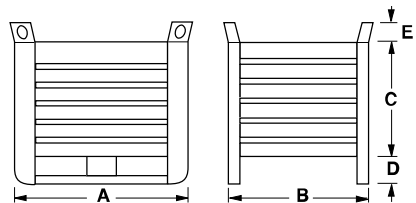

MODELLO MODEL	DIMENSIONI . DIMENSIONS					PORTATA kg CAPACITY kg
	A	B	C	D	E	
SL 086	1000	800	520	150	110	1500
SL 032 M	1000	800	650	150	110	1500
SL 032 P	1000	800	650	150	110	2000
SL 031 M	1200	800	650	150	110	1500
SL 031 P	1200	800	650	150	110	2000
SL 087	1200	1000	650	150	110	1500
SL 088	1300	1000	700	150	110	1500



SLITTA LATO LUNGO  
SKID LONG SIDE

PORTA SUL LATO CORTO  
DOOR ON SHORT SIDE



MODELLO MODEL	DIMENSIONI . DIMENSIONS					PORTATA kg CAPACITY kg
	A	B	C	D	E	
SL 098	1000	800	650	150	110	1500
SL 099	1200	800	650	150	110	1500

PORTA SUL LATO LUNGO  
DOOR ON LONG SIDE



SLITTA LATO CORTO  
SKID SHORT SIDE

MODELLO MODEL	DIMENSIONI . DIMENSIONS					PORTATA kg CAPACITY kg
	A	B	C	D	E	
SL 198	1000	800	650	150	110	1500
SL 199	1200	800	650	150	110	1500



# CONTENITORI IN LAMIERA

## CONTAINERS IN SHEET METAL

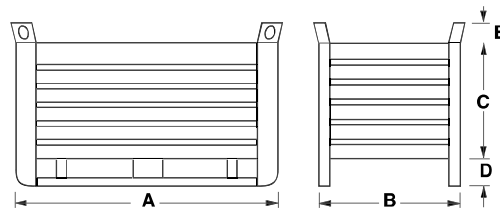

MODELLO MODEL	DIMENSIONI . DIMENSIONS					PORTATA kg CAPACITY kg
	A	B	C	D	E	
SL 030 M	1500	800	650	150	110	1500
SL 030 P	1500	800	650	150	110	2000
SL 089 M	1500	1000	650	150	110	1500
SL 089 P	1500	1000	650	150	110	2000

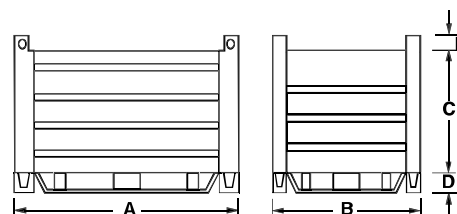

MODELLO MODEL	DIMENSIONI . DIMENSIONS					PORTATA kg CAPACITY kg
	A	B	C	D	E	
SL 407 M	1100	725	600	100	80	1500
SL 407 P	1100	725	600	100	80	2000
SL 406 M	1450	1100	600	100	80	1500
SL 406 P	1450	1100	600	100	80	2000



COPERCHIO INCERNIERATO  
HINGED LID



MODELLO MODEL	DIMENSIONI . DIMENSIONS					PORTATA kg CAPACITY kg
	A	B	C	D	E	
SL 9283	2000	1000	1000	130	65	1000